

THE VINTAGE SAILPLANE ASSOCIATION

VSA is a very dedicated group of soaring enthusiasts who are keeping our gliding history and heritage alive by building, restoring and flying military and civilian gliders from the past, some more than fifty years old. Several vintage glider meets are held each year. Members include modellers, pilot veterans, aviation historians and other aviation enthusiasts from all continents of the world. VSA publishes the quarterly magazine BUNGEE CORD. Sample issue \$ 1.-. Membership \$ 10.- per year.

For more information write:

Vintage Sailplane Association
Scott Airpark
Lovettsville, Va. 22080.

OPENS TO
1.05 in.
ABOVE WING
(801) 375-7805

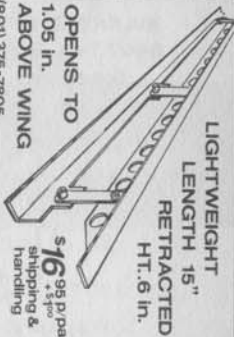

SPOILERS



You are invited to join the
NATIONAL SOARING SOCIETY

- OFFICIAL AMA SOARING SPECIAL INTEREST GROUP
- YEARLY AMA SOARING TOURNAMENTS
- NATION-WIDE SPECIAL INTEREST AWARDS PROGRAM
- EXCELLENT BI-MONTHLY NEWSLETTER
- NSS FULLY SUPPORTS THE F2B SOARING TEAM & LSF SOARING PROGRAM
- NSS IS INVOLVED IN THE ORGANIZATION AND OVERSEEING OF THE SOARING PORTION OF AMA NANTS (INCLUDING AWARDS BANQUET)
- YEARLY DUES ARE \$12.00 (SPECIAL FAMILY RATES)
- NSS OFFICERS ARE FROM ALL 11 DISTRICTS

For information, contact:
NSS Secretary/Treasurer
R. J. O'CONNOR
P.O. Box 107
Aurora, CO 80014

R/C

Soaring

D I G E S T

Vol. 3

No. 11

NOVEMBER 1986

**NATS WINNER
LEON KINCAID**



RC Soaring Digest
P.O. Box 269
Peterborough, NH 03458

BULK RATE
POSTAGE PAID
PERMIT # 69
PETERBOROUGH, NH 03458

ADDRESS CORRECTION REQUESTED
FORWARDING POSTAGE GUARANTEED

© 1986 RC Soaring Digest. Printed monthly; twelve issues per year. Edited and Published by James H. Gray, 28 East Hill Road, P.O. Box 269, Peterborough, NH 03458. Telephone number (603) 924-6759. Subscriptions: \$16/yr. in USA; \$20 (US) per year in Canada and Mexico; and \$24 (US)/year elsewhere in the world via airmail. All rights reserved. Reproduction with permission of the publisher is permitted. RC Soaring Digest, Radio Control Soaring Digest, and RCSD are registered names.

Hi Start Guest Editorial.....Bob Rondeau

Last Sunday I had planned to get in some good flying . I had my batteries charged and a couple planes ready so I called my flying buddy Ty Sawyer at his family's home which happens to be an airport. Well, the message I got was that Ty was busy ground crewing for a glider club that was putting on a pay and fly at the airport.

I threw my planes in the car and grabbed a loose check heading off for the airport. Watching this same situation last year I had been tempted to go up but I weighed the \$40 bucks against what it would buy in the new R/C catalog I just got.

My interest seemed to solidify over the year and this time I was ready and willing and had the ticket in my hand as I went out on the tarmac to say hi to Ty and get the inside poop. Ty informed me that he had been up that morning and had found plenty of lift-I'd point out that Ty has spent most of his 17 years around airplanes. His mother once told me that as a toddler he was leashed to a tie down under the wing of the family J-3 to keep him out of the traffic pattern.

I did some set-up and wing tip duty until my turn came up and then Ty introduced me to the pilot and I climbed into the front of a Schweizer 2-33 and with a warning not to touch the release knob we were off rumbling down the runway behind the tow plane.

The pilot (I forget his name) began instructing me in what was happening as we lifted off and the rumbling wheel barrow feel changed to a smooth soft climb. I had been introduced as an R/C glider flier and had assured him that I had the basic idea down having logged an hour in the right seat of a Cessna not to mention having flown all over the states in computer simulations.

This particular October Sunday was clear, bright and as we neared 3000 ft. I could still see the peak foliage colors on the trees below. My instructor was explaining the variometer, the air speed indicator and the stall speed on a 2-33 as he pulled the tow release. The drone of the tow plane faded as we banked away and headed over to an area where he had found lift earlier.

I timidly took over the controls as he directed from somewhere behind my right ear. "Feel that lift?" he said, "Bank gently to the left." I nodded and fed in some left stick and rudder until we had what I thought was about 20 degrees of bank and checked the rate of climb. It climbed up for a half revolution then drooped . I began moving the stick back to the right a bit and pulled the nose up slightly. "Not bad.." was the comment from behind me, "Try over to the right". After a couple more turns I was getting pretty cocky. I was turning into the bank with authority and feeding in opposite stick to hold up the inside tip while keeping an eye on the rate of climb and holding the turn with the rudder. " Let the plane fly the turn" came the voice at my ear, "Your using the ailerons more than you need to".

I thought I was doing great flying as I would with the Windsong I had in the back of my car down there on the ground. Thinking about the ground I glanced at the altimeter. I was shocked to see that we were nearing 1500 ft. Without my realizing it, the pilot had been directing me over to a landing position and he took over the stick as we popped the spoilers and I followed his movements on the peddles and stick. It was over in a few moments as we rolled to a stop and Ty's grin appeared in the bubble. "That was fast" he teased, "I stayed up til the pilot made me bring it down". I returned with something like "I wanted to get back in time to catch some lift with MY glider."



ACCIPITER CCT TIPPERON CONTROLLED SAILPLANE

A superbly smooth handling, responsive and stable aircraft with exceptionally wide speed range and aerobatic capabilities.

specifications:

Span	2 Meters
Wing area	723 Sq. In.
Aspect ratio	8.6 to 1
Wing loading	11 Oz./Sq. Ft.
Airfoil	Eppler 214

Control functions:

Tipperons	
Rudder	
Stabilator	
Flaps	6°Neg. 80°Pos.
Releasable tow hook (optional)	

Coupling:

Tipperons to Rudder
Flaps to Stabilator

Construction:

Wings Foam core
Balsa sheeting

Fuselage Epoxy glass

Tail feathers Built up

Price: \$159.50 + \$6.00

Shipping

Also available: **ACCIPITER CCX**

The original aileron version.

\$149.50 + \$6.00 Shipping

California residents add 6½% Sales tax

All kits are custom made.

Please allow 4 to 6 weeks for delivery.



CALIFORNIA SOARING PRODUCTS

P. O. BOX 367 • TOPANGA, CA • 90290 (213) 455-2808

LETTERS AND SOURCES

BACK IN JUNE, OZZIE OLSEN OF METAIRIE, LOUISIANA WROTE TO ME ABOUT A 'FIND' THAT HE HAD MADE...AND IT'S WORTH PASSING ON.

"Dear Jim, Several years back I developed a huge desire to get into giant scale and began looking for alternate building materials. I was talking to a friend who refurbished a Waco ZPF - fantastically beautiful airplane, and he told me of a source for aircraft-grade Sitka spruce in various dimensions and lengths. Several of my quarter-scale friends were also interested (are these the 'wee' folk, Oz?) so I wrote to Posey Manufacturing Company, P.O. Box 418, Hoquiam, Washington 98550. I was surprised and pleased to learn that we could purchase Sitka spruce in thicknesses of 1/4-inch and up, and in lengths of 60 inches and over...ideal for the long wings and fuselages of quarter-scale projects, and just great for those long skinny sailplane wings! The bottom line is this: we were able to buy 60 pieces in thicknesses of 1/4", 3/8", and 1/2" all 6" wide and 60" long. Total cost, including freight from Washington to New Orleans was approximately \$170. We divided the batch into three portions and cut strips of various widths on a table saw, using a 10-inch, 100-tooth, carbide tipped blade. I was amazed with the quality and smoothness of the resulting strips. Since then, I've built three quarter-scale birds and an 84-inch Quaker...and I still have enough lumber to last me a long time. I wouldn't hesitate to recommend Posey Manufacturing to any RCSD readers, as the quality of the wood is excellent. I have never seen such tight-grained wood anywhere; the price is unbeatable, even if you take into account the time spent in cutting all of those strips. Also, bear in mind that there aren't many sources for strip wood in these lengths. I assume that RCSD readers are acquainted with the properties of Sitka spruce: only slightly heavier than balsa, but much stronger.

"Some years back, I was able to buy some Sitka spruce plywood from a source in Washington. It was great stuff: very strong and super light. Unfortunately, I lost their address in one of my office moves. Although I still have some of this wood on hand, I'd like to get some more. Perhaps some of your readers know of such a source. (Signed) Oz."

THANKS FOR THE TIP, OZ. I KNOW THAT OUR READERS HAVE ANY KIND OF INFORMATION ANY OF US MAY NEED...SO JUST WAIT A MONTH OR TWO, AND WE'LL HAVE THE ANSWER FOR YOU. YOUR INFORMATION WILL REALLY HELP ALL OF US WHO PLAN A CROSS-COUNTRY 'MONSTER', OR WHO JUST PLAIN NEED SOME GOOD SPRUCE. INCIDENTALLY, JUST FOR FUN, IF ANY OF YOU HAVE LUMBER YARDS THAT DEAL IN STAIR TREAD, RAILING, OR LADDER MATERIAL, HAVE A LOOK IN THEIR YARDS...MANY WILL HAVE THE SPRUCE YOU NEED, AND WILL STRIP IT FOR YOU AT A DECENT PRICE. WHILE IT'S TRUE THAT WOODEN LADDERS AREN'T ALL THAT COMMON ANYMORE, STAIR-BUILDING MATERIALS ARE...AND IT WOULD BE WORTHWHILE TO HAVE A LOOK. (JHG)

CHANGES OF ADDRESS

MANY OF US HAVE BEEN DEALING WITH GEORGE SPARR, PROPRIETOR OF AEROSPACE COMPOSITES...AND YOU OUGHT TO KNOW THAT HE HAS MOVED TO SUNNY CALIFORNIA. HE IS STILL IN BUSINESS, AND IS OFFERING SOME ADDITIONAL NEW AND DIFFERENT MATERIALS IN KEEPING WITH HIS PLEDGE TO BRING YOU THE LATEST AND BEST. HERE'S THE NEW ADDRESS INFO:

AEROSPACE COMPOSITE PRODUCTS
DEPARTMENT "S"
P.O. Box 16621
IRVINE, CA 92714

BAD NEWS:

UNFORTUNATELY, WE HAVE NO NEWS TO REPORT ABOUT SUPERWINGS, EXCEPT TO SAY THAT WAYNE CUSTER HAS NOT BEEN ANSWERING CORRESPONDENCE OR FILLING ORDERS. APPARENTLY, HE MOVED TO CALIFORNIA SOME TIME AGO IN PURSUIT OF A NEW JOB, AND HAS NOT BEEN DOING ANY SUPERWINGS BUSINESS. BECAUSE OF THE UNCERTAINTY IN DEALING WITH THIS COMPANY, I AM GOING TO RECOMMEND THAT YOU DO NOT SEND ANY MONEY OR ORDER ANY MATERIALS OR PRODUCTS FROM THEM. I APOLOGIZE TO YOU FOR ANY INCONVENIENCE THIS MAY HAVE CAUSED, AND WILL BE EXTRA CAREFUL IN THE FUTURE ABOUT RECOMMENDING NEW SOURCES OF SOARING PRODUCTS UNTIL THEY HAVE PROVEN THEMSELVES.

GOOD NEWS

ON THE OTHER HAND, WE DO HAVE SOME VERY GOOD NEWS FOR YOU ABOUT ONE OF OUR REGULAR ADVERTISERS, A COMPANY THAT HAS RECEIVED A LOT OF PRAISE FROM SATISFIED CUSTOMERS OVER THE YEARS: VIKING MODELS, USA. JERRY SLATES IS A FINE MAN TO DEAL WITH PERSONALLY, AND HIS REPUTATION AS A GLASS LAYUP MAN IS WIDESPREAD. YOU CAN GET SOME VERY NICE FIBERGLASS FUSELAGES FROM HIM, AS WELL AS PLANS, ACCESSORIES, AND ALL KINDS OF GOOD THINGS THAT YOU NEED. HE HAS A SUPER LINE OF BELLCRANKS, TOO. IN SCALE, JERRY CAN GET YOU GOING WITH A LARGE NUMBER OF SOME PRETTY EXOTIC TYPES. LOOK AT HIS AD IN THIS ISSUE FOR SOME OF THE LATEST RELEASES IN HIS PRODUCT LINE...AND WHEN YOU DO BUSINESS WITH HIM, PLEASE MENTION RCSD. OH YES, IF YOU HAVE BEEN WONDERING WHERE TO GET THAT SUPERTAPE FOR SKINNING FOAM CORES, JERRY HAS IT IN QUANTITY.

PRODUCT NEWS

I'VE JUST RECEIVED MY KIT OF THE TIPPERON-CONTROLLED SAILPLANE ACCIPITER CCT, AND IT'S GORGEOUS! THE KIT IS WELL PLANNED, THERE IS EVERYTHING YOU WILL NEED EXCEPT FOR PAINT, COVERING AND ADHESIVES, AND THE FUSELAGE OF FIBERGLASS---WING CORES OF FOAM. THESE ARE PUT TOGETHER ON A ONE-MAN, ONE-KIT BASIS IN SPARE TIME, SO EXPECT A SIX-WEEK DELAY IN YOUR ORDER DELIVERY. HOWEVER, YOU WILL GET THE PRODUCT, AND YOU WILL BE PLEASED. THE ORIGINAL AILERON VERSION IS ALSO AVAILABLE AT A SLIGHTLY LOWER PRICE. SEE THE AD IN THIS ISSUE FOR THE DETAILS FROM CALIFORNIA SOARING PRODUCTS.

ANOTHER GREAT PRODUCT.. (SLIGHTLY OFF THE BEATEN PATH FOR US RC'ERS)

AS MOST OF YOU KNOW, I FLY THE FULL-SIZE SAILPLANES AND AIRPLANES. MANY OF YOU DO, AS WELL, AND IF YOU'RE LIKE ME YOU ARE ALWAYS ON THE LOOKOUT FOR GOOD PRODUCTS THAT YOU CAN USE WITH GOOD RESULTS. FOR ABOUT THREE YEARS, I HAVE BEEN USING SUCH A PRODUCT FROM COMMUNICATIONS SPECIALISTS, WEST TAFT AVENUE, ORANGE, CALIFORNIA. THE PRODUCT IS AN AIRCRAFT TRANSCEIVER - HANDHELD - THAT PROVIDES ONE WATT OUTPUT IN ALL 720 CHANNELS OF THE AIRCRAFT COMMUNICATIONS VHF BAND. IT ALSO RECEIVES ON THOSE CHANNELS, TOO, AND ALSO PROVIDES RECEPTION ON THE 200 NAVIGATION CHANNELS.

THE RADIO IS CALLED THE TR-720, AND I HAVE USED IT IN A COUPLE OF MY SMALL PLANES WITH GREAT RESULTS. ORDINARILY, IT WOULD BE CONSIDERED FOR USE IN ULTRA-LIGHTS, IN GLIDERS, OR IN OTHER APPLICATIONS WHERE A BACK-UP TRANSCEIVER IS NEEDED, BUT A STANDARD RADIO IS NOT AVAILABLE. THE TR-720 IS USEFUL TO CARRY AROUND, TOO, AND CAN BE WORN ON THE BELT IN ITS HOLSTER. IF YOU HAPPEN TO BE OUT THERE ON THE LINE DIRECTING AN AIRCRAFT INTO A PARKING SPOT, YOU'LL FIND IT TO BE EXACTLY WHAT YOU NEED.

NOW, SPENCE PORTER AND HIS PEOPLE AT COMM-SPEC HAVE COME UP WITH A SMALL, LIGHT, AMPLIFIER THAT INCREASES THE OUTPUT OF THE TRANSCEIVER FROM ONE WATT TO TEN WATTS. THIS AMPLIFIER NOW TURNS THE HANDHELD INTO A VOICE THAT CAN BE HEARD AS WELL AS OR BETTER THAN THE USUAL PANEL-MOUNTED RADIOS...YET IT DOES NOT LOSE ITS FLEXIBILITY. ALL KINDS OF ACCESSORIES ARE AVAILABLE, INCLUDING BATTERY PACKS, CHARGERS, CASES, MOUNTING TRAYS, ANTENNAS, AND WHATEVER ELSE YOU MAY NEED FOR YOUR AIRCRAFT COMMUNICATIONS. THOSE OF YOU WHO HAVE ALREADY USED THE TR-720 KNOW THAT IT HAS A FABULOUS RECEIVER. NOW, WITH THE CS-10 AMPLIFIER, YOU ALSO HAVE A FABULOUS TRANSMITTER JUST WAITING TO BE INSTALLED IN YOUR AIRCRAFT, IN YOUR CAR, OR IN YOUR HOME AS A GROUND STATION.

IF YOU'RE INTERESTED IN THIS PRODUCT WITH ITS 3-YEAR WARRANTY (!) CALL OR WRITE SPENCE PORTER OR MIKE BEVERIDGE AT COMMUNICATIONS SPECIALISTS OUT THERE AT 426 WEST TAFT AVENUE FOR THEIR LITERATURE. YOU'LL BE GLAD YOU DID.

**** **

SOME NEW DEVELOPMENTS TO SHARE WITH YOU ABOUT RCSD...

LEE MURRAY HAS ACCOMPLISHED A TOUR DE FORCE, BY CATALOGING ALL BACK ISSUES OF RCSD AND COMPILING A "KEY WORD" AND "KEY SUBJECT" INDEX. ACTUALLY, HIS WIFE BARBARA DID MUCH OF THE WORK... BUT THE MAIN POINT IS TO TELL YOU THAT THIS KEY-WORD, KEY-SUBJECT INDEX WILL BE PRESENTED TO YOU IN SEVERAL ISSUES OF RCSD -- SO THAT YOU WILL BE ABLE TO FIND THINGS IN BACK ISSUES. LEE IS A 'WHIZ' WITH A COMPUTER, AND PROVIDES SOME VERY INTERESTING DESIGN PROGRAMS FOR SAILPLANES, AS MOST OF YOU KNOW WHO HAVE BEEN READING RCSD FOR AWHILE. NOW, LEE HAS DONE ME - AND YOU - A GREAT SERVICE BY PROVIDING THE COMPREHENSIVE LIST OF ARTICLES AND SUBJECTS FROM RCSD. I PLAN TO BEGIN IN THIS OR MAYBE THE

NEXT ISSUE, AND WILL CONTINUE UNTIL IT'S COMPLETE. THIS WILL BE AN ON-GOING THING. THANKS, LEE.

FLYING SITE INFORMATION WANTED...

AS I MENTIONED A FEW ISSUES AGO, JERRY SLATES OF VIKING MODELS IS REQUESTING THAT YOU SEND INFORMATION TO HIM ABOUT YOUR FLYING SITES: WHERE THEY ARE LOCATED, HOW TO GET TO THEM, WHOM TO CONTACT, ETC., ETC. THE IDEA WILL BE TO COMPILE A LIST FOR PUBLICATION, SO THAT WHEN YOU ARE VISITING ANOTHER PART OF THE COUNTRY ON YOUR VACATION OR ON BUSINESS, YOU'LL BE ABLE TO CONTACT ANOTHER SAILPLANE OWNER/FLIER, AND PERHAPS SOAR WITH HIM OR HER AT A NEW SITE AWAY FROM YOUR HOME. PLEASE SEND THE INFO TO ME OR TO JERRY (HIS ADDRESS ON HIS AD, BACK COVER) AND HE'LL PUBLISH THEM AS A PART OF HIS CATALOG OF SOARING SUPPLIES.

BUILDING BOARD FOR MODELLERS....

ONE OF THE STURDIEST, STRAIGHTEST, AND MOST CONVENIENT BUILDING BOARDS I'VE SEEN IS NOW AVAILABLE FROM COUNTRY HOBBY SUPPLIES, RR#1, DUNDAS, ONTARIO, CANADA L9H 5E1. WRITE TO OTTO BANDMANN AT THIS ADDRESS, AND ASK FOR HIS PRICES ON THESE GREAT BOARDS. THEY ARE CORK-COVERED COMPOSITION BOARD, LAMINATED WITH AIRSPACE BETWEEN THE TWO SURFACES TO MAINTAIN FLATNESS AND CONSISTENCY OF EXPOSURE TO ATMOSPHERIC MOISTURE...THUS AVOIDING BENDING. BOTH SURFACES ARE CORK COVERED, AND A FRESH SURFACE CAN BE EXPOSED WHEN THE OLD ONE IS USED UP, MERELY BY TURNING THE BOARD OVER. THE BOARD IS ABOUT TWO INCHES THICK, FROM SURFACE TO SURFACE, AND MEASURES TWO FEET BY FOUR FEET IN WIDTH AND LENGTH, RESPECTIVELY. LARGE ENOUGH TO BUILD MOST WINGS AND FUSELAGES ON, YET SMALL ENOUGH TO TUCK AWAY WHEN NOT NEEDED. MINE HAS HAD A REAL WORKOUT SINCE LAST JULY WHEN I GOT IT, AND STILL DOES NOT NEED TURNING OVER! THEY CAN BE SHIPPED UPS, TOO.

*** **

SAFE-T-POXY

AIRCRAFT SPRUCE & SPECIALTY - 800-824-1930 OR 800-233-9686 HAS SOME OF THE NEW "SAFE" EPOXY AVAILABLE IN "PRACTICE" KITS (ACTUALLY OF IDEAL SIZE FOR MODELLING USE) AT A PRICE OF \$16.30 PLUS UPS SHIPPING. THE KIT CONTAINS 1½ QUARTS OF EPOXY, AND YOU'LL FIND THAT THIS EPOXY TENDS TO BE LESS IRRITATING TO USE THAN ALMOST ANY OTHER YOU MAY HAVE TRIED.

WING-COVERING MATERIAL FOR THOSE FOAM CORES...

HARRY FINCH PASSED ON A NICE HINT TO ME ABOUT USING POLY-CARBONATE SHEETS INSTEAD OF Balsa OR THIN PLYWOOD TO COVER YOUR

FOAM-CORE WINGS. IT IS AVAILABLE IN THICKNESSES OF ABOUT .010" AND HAS ONE SHINY SURFACE AND ONE MATTE SURFACE. WHAT YOU DO IS PAINT ONE SURFACE WITH A COLOR COAT OF YOUR CHOICE, AND THEN STICK THAT SURFACE TO THE CORE BY CONVENTIONAL MEANS. THE CLEAR SHINY SURFACE NOW LOOKS LIKE IT'S A MILE DEEP OVER THE COLOR, AND THE 'SLICKNESS' OF THE FINISH IS BETTER THAN MOST MODELLERS CAN GET WITH GREAT EFFORT. BEST OF ALL, IT'S FAST AND EASY TO DO...OH YES, POLYCARBONATE: IT'S KNOWN AS LEXAN™ FROM SOME SUPPLIERS. CALL YOUR LOCAL PLASTICS SUPPLY HOUSE IN THE YELLOW PAGES TO FIND THE SOURCE CLOSEST TO YOU. THANKS, HARRY.

WHAT'S NEW? ...THE SUNRISE 66...R/C HAND-LAUNCH SAILPLANE

PERFORMANCE DESIGNS, 2105 SE 85TH AVENUE, PORTLAND, OREGON 97216, HAS A NEW SAILPLANE THAT ERIC JACKSON (ALOHA, OREGON) SAYS IS A GREAT FLIER. THE SHIP HAS A 66-3/4" SPAN, A WING AREA OF 443 SQ. IN. AND AN EPPLER 38/ AIRFOIL. IT WEIGHS ONLY 11 - 13 OUNCES, READY TO FLY...DEPENDING ON YOUR RADIO.

ERIC SAYS: "THE SHIP IS KITTED BY PASS MEMBER CRAIG ROBINSON, AND COSTS \$34. IT IS TOP-NOTCH WITH HAND-SELECTED WOOD THROUGHOUT. ALL PARTS ARE HAND MCHINED, AND THEY FIT! THE REASON I AM SO HIGH ON THIS BIRD IS THAT IT'S A SUPERIOR FLYING SAILPLANE, AND WHERE I USED TO HAVE TO WORK MY TAIL OFF TO GET 3 OR 4 MAXES WITH MY OWN DESIGN PTERON, TODAY I HAD 8 MAXES AND 3 FLIGHTS THAT WERE ABOUT 10 SECONDS SHY OF A MAX! SUNRISE WILL WORK THE LIGHTEST LIFT, AND PENETRATION IS QUITE ADEQUATE. I GO WAY DOWNWIND WITH MINE (MY STYLE) WITH NO PROBLEMS. (Yeah, Eric...but how about getting back? JHG). I CAN LAUNCH IT TO ABOUT 50 OR 60 FEET IN NO WIND! WE FLY ON THE SLOPE, TOO AND HAVE SUNRISE RACES...A TOTAL BLAST. JUST LIKE Q-TEE PYLON RACES, ONLY BETTER. HATE TO SOUND LIKE A SALESMAN BUT YOU HAVE TO HAVE ONE!

Okay, Eric, I believe you -- but RCSD readers will have to know that the pilot has a little to do with that kind of performance, too. Please write up a nice product/kit review for RCSD, and give us all the details of construction and flying. I'm sure that our readers will want to check a SUNRISE out for themselves. JHG.

==== REMOTE CONTROL AERIAL PHOTOGRAPHY ====
by: Lee Murray

I recently strapped a camera to my RO-8 sailplane using #64 rubber bands. The photographs didn't copy well enough for this newsletter but showed views over an amazing area, the expanse of the sod farm and in another the sailplane coming in for a landing. The diagram below shows how easy it is. The dead air flight times went from about 4 minutes down to about 2 with the extra drag.

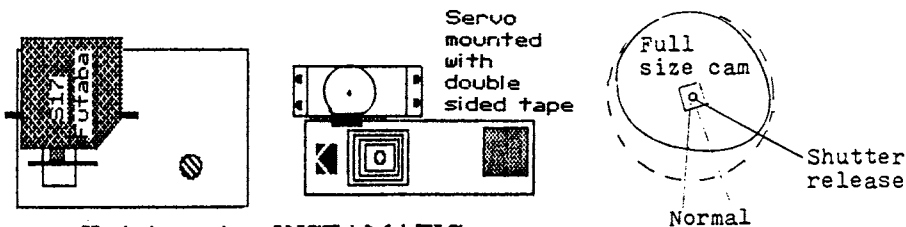

Kodak pocket INSTAMATIC camera with servo having cam to depress shutter when control is activated.

...and STILL THEY KEEP COMING.... Horten IV plans (full size)

"Dear Jim, I have for sale a set of original Horten IV plans, incomplete, but all that is known to exist. They are on 18" by 24" blue-line, 21 sheets altogether. A 223-page manuscript with airfoil co-ordinates is also available. Plans \$25 ppd.; manuscript \$50 ppd.; and airfoil coordinates (41 pages) are \$10 ppd. I'll sell all for \$71 postpaid.

"The plans set includes the center section, wing construction, outer wing control surface construction and movement/twist, and a 2-view with station locations. The manuscript has stress analysis, airfoil coordinates and theory...all in German. Please make check payable to Flight Engineering and Development, P.O. Box 667, Dallas Georgia 30132. (Signed) H.H. Cherry."

Thanks, "HH". I'll print your letter in RCSD, and mention that the Horten IV was one of the most amazing flying wing sailplanes ever designed. It had an extremely high aspect ratio and very good performance for its day (end of WWII) although it never achieved its full potential, due to many factors, including the fact that the Horten brothers moved apart following the war...Reimar to Argentina and Walter remained in Germany. The factory was never re-started (as far as this writer is aware) and all experiments came to a halt. Reimar did design a couple of flying wing foot-launched sailplanes in Argentina, but these are either non-existent now, or so badly battered by time that they are un-flyable. One of the remaining Horten IV sailplanes was brought to the United States after the war, and was flown at one of the early post-war contests in Texas, I believe. It was piloted by Ray Parker, among others. A handful to fly on take-off, the pilot was in the prone position -- said to be very comfortable for long flights -- but in some ways difficult.

Anyone who is interested may find more information about the Horten IV from the Soaring Society of America, P.O. Box E, Hobbs, New Mexico, through their magazine SOARING, and also through the affiliated organization: Vintage Sailplane Association (see ad in this issue). It is too bad that insufficient time, money and effort were devoted to realizing the Horten IV potential. It could have been developed into an incredibly efficient soarer - which it was for its time - but there remained so many problems that the general lack of interest in trying to overcome them killed its potential.

HH Cherry has developed his own flying wing, foot-launched sailplane which looks remarkably like the Horten IV, but is of course much smaller. I understand from HH that a student at Texas U. has built a wind-tunnel test model of the Cherry design, which will be wind-tunnel tested in the near future. (JHG.)

More Correspondence...about Ptaero(dactyls) and such...

Ernie Currington strikes again! It's Ernie, you may recall, who sent us the info on flight trimming, balsa strippers and other esoterica. He's always good for some interesting material, and is a first-class correspondent. Now he's come up with some more things that I think you'll like. Heeeerrrees Ernie...

"I'm enclosing a couple of pictures. One is my Ptaero (dactyl) in its nude state. It's now covered and waiting radio installation, de-warping and flying. The other (photo) is of me and my 2M Phlaneur. This one is waiting repair (after I dug a tip in on a final turn too low to the ground). Not serious, and the kind of thing that, if necessary, could be turned around overnight (less painting). See photos on page 15.

"My winter book is full with a number of technical things to do: a 'Slimini' -- that is, a one-servo-wide GEMINI, with plug-in wings. Also have a MIRAGE kit, and am expecting a STEPP 3 kit. Next, after the GEMINI, I'll be starting L'Hirondelle-4 bis. (My French grammar says that this is either a small river steamer or a swallow...I'll opt for the swallow. JHG). This is an updated version of my smaller cross-country ship (150", 1580 squares) that I blew up in Ottawa. This one will be slimmer with a longer nose (to avoid the 6 oz. of lead that I had to use in the earlier one). It will have the same wing section as the Phlaneurs I & II, and the same force setup. The kits, by the way, are just in case I can't finish the 4 bis in time. Scratch building an airplane of this size from a scartch design is time consuming. Oh yes, I almost forgot: I'm also building a small, light weight, 55"-span ship with a one-piece wing that I can fit into the back of my Escort without taking it apart (the glider, not the car --JHG).

"Here's a couple of ideas for the RCSD readers:

Rafael's Switch - a simple, low-drag, light idea for an on-off switch by Rafael Ramirez of the Montral club.

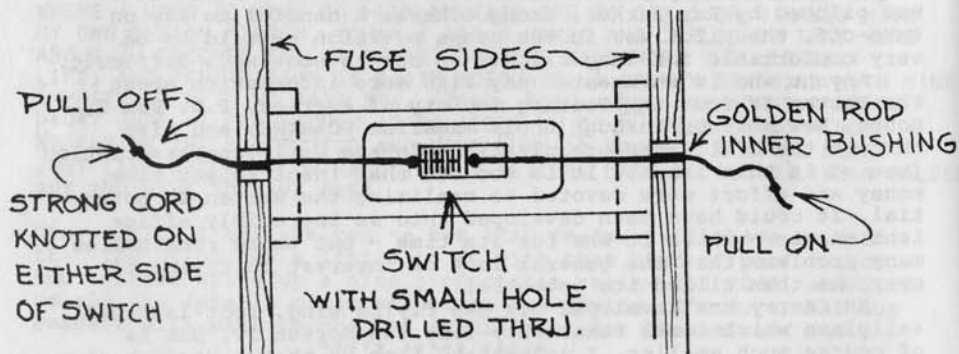

Stan's Switch - by Stan Sarskas of the Montreal Club.

As above, but a hole in the switch button is drilled and tapped for a 2-56 screw; push off, pull on.

Both have the benefit that the switch cannot be turned on inadvertently. (I might add that it is also of benefit that the switches can't be turned off inadvertently, either...as in launching, for example...JHG).

Correction; It was incorectly reported in the October issue that the Madison Area Radio Control Society would hold their annual Sailplane Symposium on November 9th and 10th. The correct dates are November 1st and 2nd.

STILL MORE MAIL...

Leon Kincaid, after reading the September RCSD, wrote as follows: "Dear Jim: I received the September RCSD the other day and read it right away as always.

"I meant to write to you right after the Nats, but kept putting it off. I'm sure you know it by now, but I not only won first in Unlimited, I also won the 'Hi Johnson' trophy for the highest score in any class. Anyway, the picture was taken in my front yard, so the background is not ideal.

"About the winglets; (John) Gunsaulus had the winglets on his SCOOTER. They do make for better turns, but I feel they slow the plane down and keep the airfoil from reaching its peak performance...at least this particular airfoil.

"By the way, watch CBS this season for Dreams of Gold with Cliff Robertson and Loretta Awitt. One of the actors in the movie plays my son, Don Kincaid. I saw a special preview of the film the other day.

"I'll close for now, (signed) your friend, Leon"

Thanks, Leon, for setting me straight about the winglets and the SCOOTER. We all congratulate you for your impressive win at the NATS with your own design, and especially for the Hi Johnson Trophy award. Hi was a very dear personal friend of mine, and I miss him very much. The trophy couldn't have gone to a better or more deserving pilot. Congrats again. Jim Gray.





GARY WAGNER'S 2-METER SAILPLANE SEEN AT WINTONBURY, CT MEET. SHIP FEATURES BUILT-UP, FULLY-SHEETED WING WITH HUGE FLAPS AND SMALLISH AILERONS. BEAUTIFUL CRAFTSMANSHIP THROUGHOUT. FINISH IS DOPE OVER DOMESTIC TISSUE TRIM.

HAND-MADE, FLUSH-FITTING TOWHOOK
- WAGNER'S 2-METER

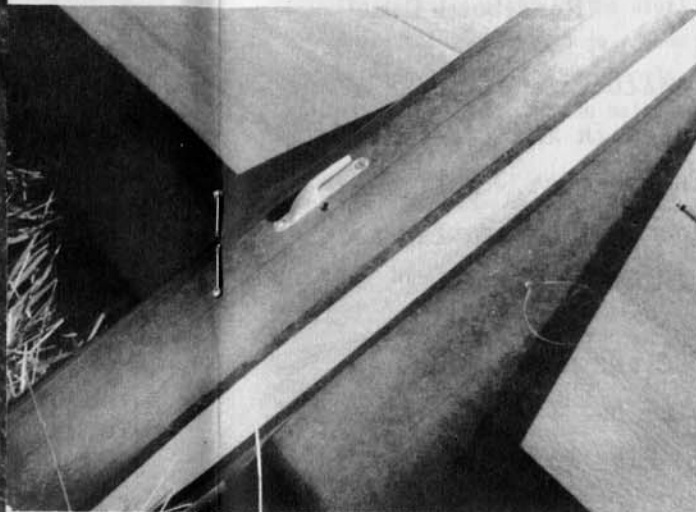

WAGNER'S CONCENTRIC HINGES ARE USED ON RUDDER, AILERONS AND FLAPS. LOW DRAG AND ALMOST GAPLESS. NEAT.

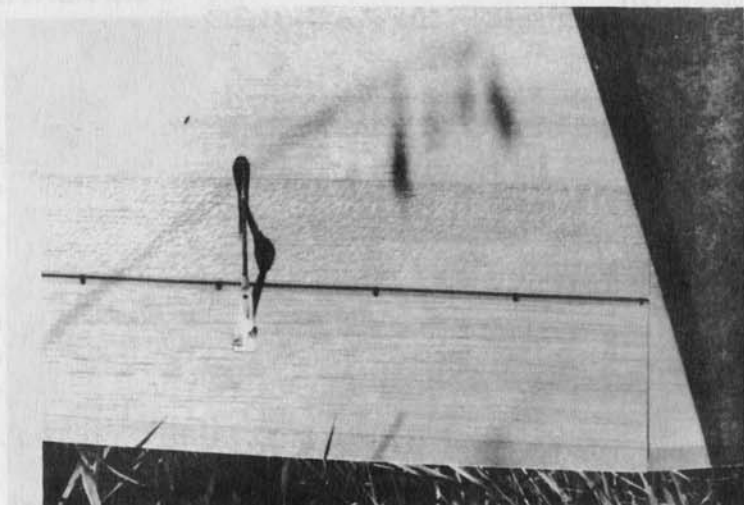
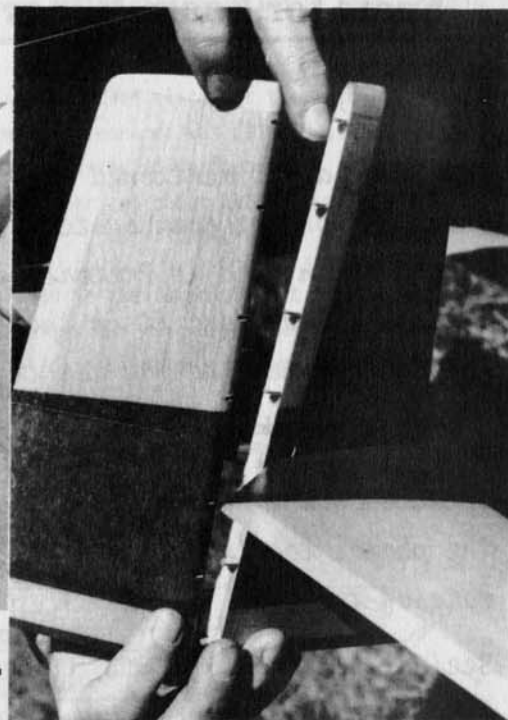

CLOSEUP OF WING BOTTOM ON WAGNER 2-METER SHOWS CLOSE-FITTING FLAP HINGE AND FLUSH-MOUNTED HORN. FAIRINGS TO COME.



JIM TYRIE, BEDFORD, NH POSES WITH HIS NEW SAMUN WHICH FEATURES ALL FIBERGLASS CONSTRUCTION, INCLUDING WINGS!

Spars for Foam Wings

John Lightfoot

66 Second Avenue,
Rondebosch East.
7700

Dear Jim,

Some time ago I mentioned the possibility of doing a short bit on the spar system I used in the ill-fated SB X-C which died in Pretoria in November. Well, here it is! I have done it in the format I habitually use for Southeaster and may use it there some time.

As you can see, I have traced the one photo to show details of the Hayward spar system but I have included the photos too in case you would like to use one or more of them.

Seeing the Hands Off Foam Cutter sketch in the latest issue I have been planning a home made version. The technician was out to service the big Xerox machine at school (the one I use for Southeaster!) and I was able to part him from a couple of toothed belts and an aluminium toothed pulley which I sliced in half to give the two pulleys necessary for the main control. Insinuations that that was the reason for calling out the technician in the first place will be vigorously denied!!!

When I had to create a large soarer to use in the F3H Cross Country event last year, I had to build fast and cheap. Foam cores were the obvious way to go but a 4 metre wing had to have more than just skins to give it strength. There had to be a spar of some sort but how to put one into the cores with least hassle and expense?

The end result was so simple it was almost too good to be true but it went together easily enough and the flying we managed before disaster struck proved that it was strong. It handled a fast launch with very little flexing and withstood the fatal crash ... my son tested the remains by putting each section across the arms of a chair and sitting on them! He

had to bounce before there was more than a mild creak and it took a couple of hefty bounces to break them!

The cores were cut in the usual way and then sliced at the thickest point, where the spar was to go. Some extra clearance was allowed at the joints between inner and outer panels, to take the joiner tubes and a longer cut-out at the root for the main wing joiner and about half a metre of 1,6 mm ply spar.

The lower skin was epoxied and placed in the lower off-cut and then strips of glass cloth (about 3oz), three times the wing depth, were applied at the spar position and folded over onto top and bottom surfaces.

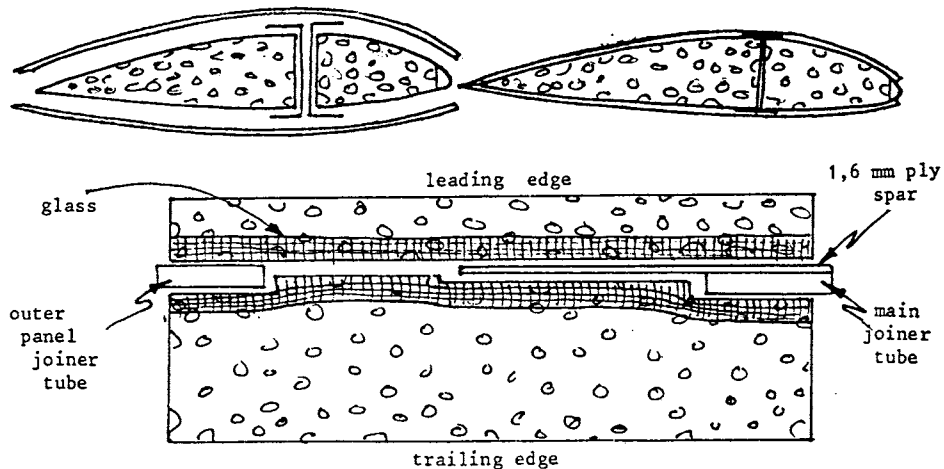

Strips were applied to both front and back sections so that when they were placed on the lower skin and pushed together they formed an "I" beam of glass and epoxy. The upper skin was applied and the whole lot squeezed together in the original off-cut under a dozen bricks!

When I mentioned that I might do a write-up on the construction, Jim must have misunderstood me because he commented that his readers would like an article on putting spars into already-skinned (skun?) wings. Sometimes, however, things work out right and it happened that Chris and Dave Hayward were in the process of doing just that, putting a spar into a wing already covered with veneer!

The spar was a hefty affair, made from a pair of spruce strips top and bottom, with 1 mm ply webs front and back.

The cores were cut at the deepest point and the foam trimmed back using a hot wire, to half the thickness of the spar in each core half.

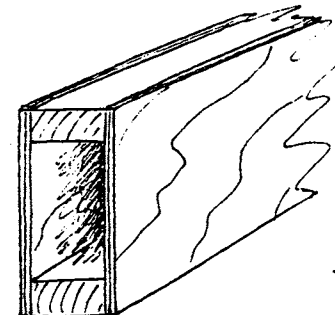

The fact that the spar is hollow from end to end can be used to hold a blade type wing joiner and/or leads to outboard aileron servos. In the Haywards case they fitted a snake tube to the front face of the spar and mounted a bell-crank on the back face, necessitating a little extra mining in the foam to give clearance.

The whole assembly is finally put together with epoxy in the original foam off-cuts and held either by bricks or vacuum.

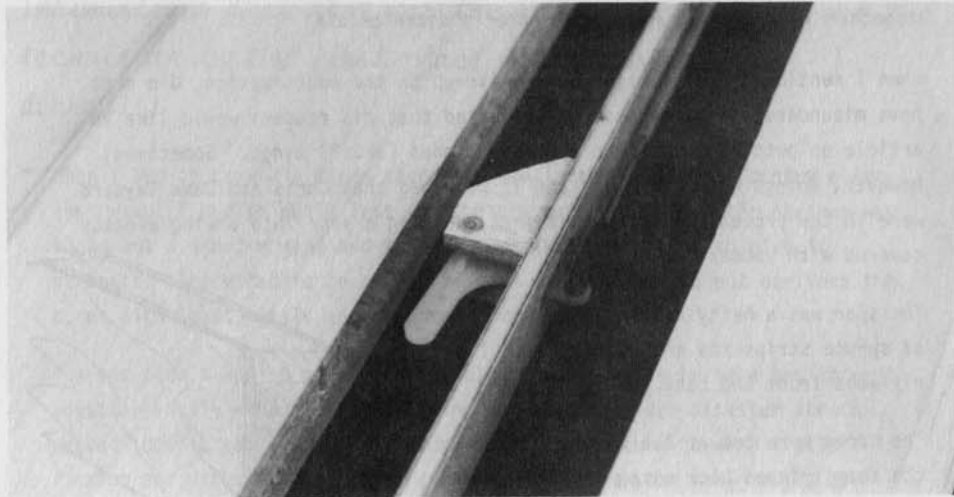
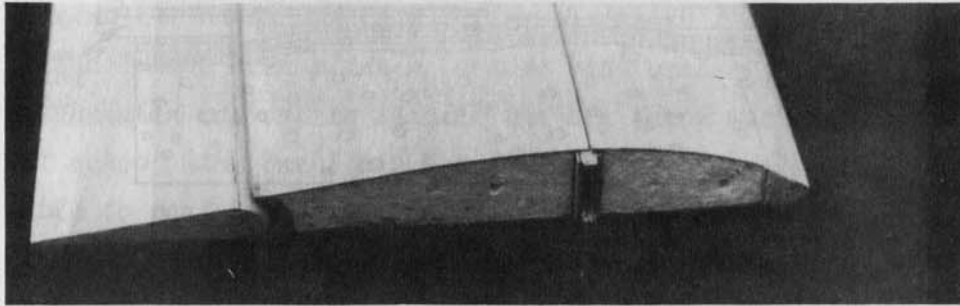
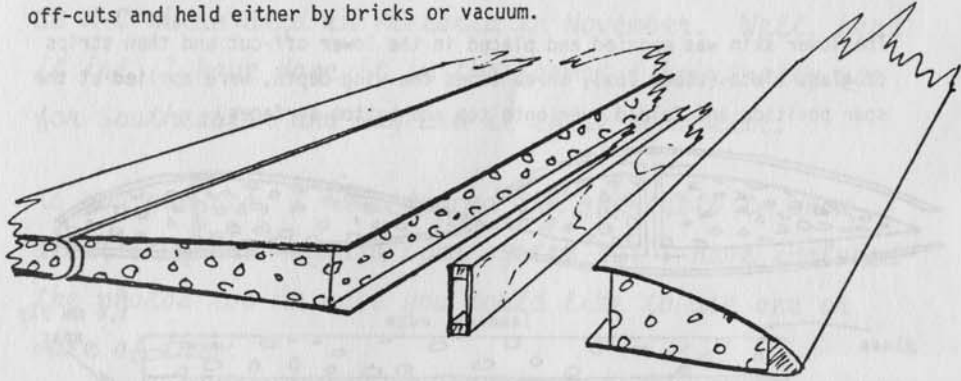

Ernie Currington's Ptaero (dactyl) in bare frame state and his 2-meter Phlaneur. See "More Correspondence" on page 7.

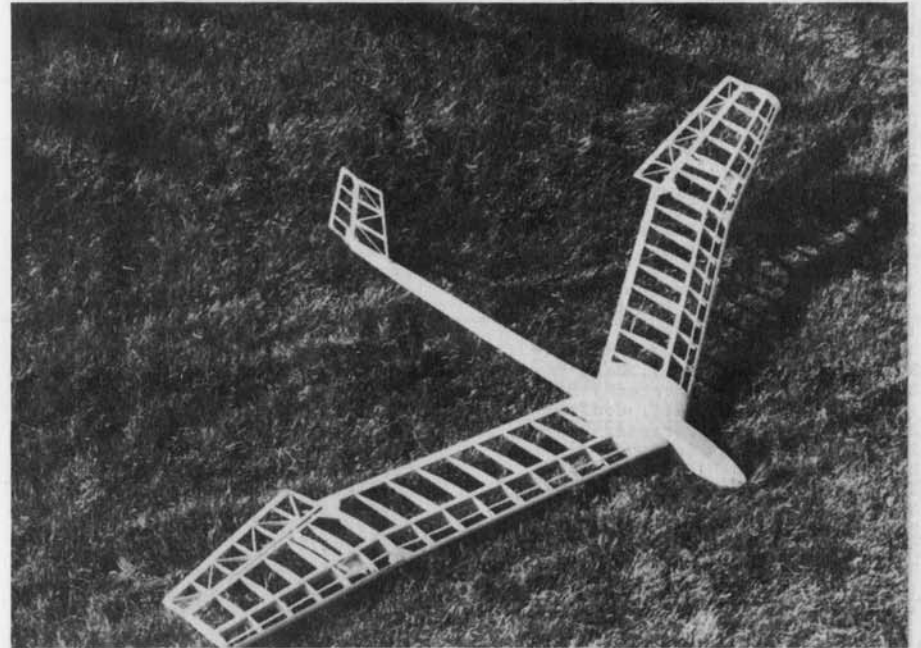

File: RCSD. REFERENCES

Report: Ref/A

VOL NO	DATE	PAGE	CONTRIBUTOR	KEY WORDS
2	9 Sep 85	6	Sawyer, Ty	Aerial Photography
1	6 Jun 84	1	Drury, Rick	Aerodynamics
1	8 Aug 84	3	Drury, Rich	Aerodynamics
3	1 Jan 86	4	Currington, Ernest	Aerodynamics
3	3 Mar 86	12	Currington, Ernest	Aerodynamics
3	5 May 86	3	Simons, Martin	Aerodynamics
2	4 Apr 85	4	Larsen, Orla	Aerodynamics, Airfoil
2	8 Aug 85	4	Simons, Martin	Aerodynamics, Airfoil
3	3 Mar 86	5	Fraser, David	Aerodynamics, Airfoil
2	12 Dec 85	5	Abell, Bruce	Aerodynamics, Construction, Wing
2	11 Nov 85	12	Currington, Ernest	Aerodynamics, Design, X-Country
2	9 Sep 85	10	Benson, John	Aerodynamics, Slope Soaring, Flying
3	5 May 86	14	Fraser, David	Aerodynamics, Stability, Software
1	9 Sep 84	4	Broggini, Don	Aerodynamics, Trimming
1	11 Nov 84	8	Murphy, Jeff	Aerodynamics, Trimming
1	5 May 84	6	Nicks, O.W., et.al.	Aerodynamics, Wing
2	4 Apr 85	6	Dietrich, Jack	Aerodynamics, Wing
2	5 May 85	4	Kahn, Raja	Aerodynamics, Wing
2	5 May 85	10	Chernoff, Max	Aerodynamics, Wing, Construction
1	3 Mar 84	12	Metze, Scott	Airfoil
1	7 Jul 84	2	Folkening, Dale	Airfoil
3	6 Jun 86	17	Gray, Jim	Airfoil
1	9 Sep 84	3	Blanchard, Woody	Airfoil, Aerodynamics
2	11 Nov 85	5	Abell, Bruce	Airfoil, Aerodynamics
3	4 Apr 86	14	Reed, Mike	Airfoil, Aerodynamics
3	4 Apr 86	3	Tinker, Neil	Airfoil, F3B
1	2 Feb 84	3	Costlow, Red	Airfoil, Plotting
1	9 Sep 84	1	Fraser, David	Airfoil, Plotting
1	4 Apr 84	2	Bonnell Rich	Autopilot
3	4 Apr 86	7	Thomas, Ben	Autopilot, Control
3	6 Jun 86	2	Carr, Pete	Autopilot, Control
3	8 Aug 86	3	Waynard Hill	Autopilot, Control
2	5 May 85	13	Murray, Lee	Batteries
2	8 Aug 85	14	Murray, Lee	Batteries
3	2 Feb 86	15	O'Brien, Oz	Batteries
1	8 Aug 84	3	Searcy, Marshall	Clubs
3	4 Apr 86	5	Breunig, Cal	Clubs
1	1 Jan 84	0	Gray, Jim	Communications
1	1 Jan 84	7	Stokely, Herk	Communications
1	7 Jul 84	6	Gray, Jim	Communications
1	8 Aug 84	8	Spackman, Glen	Communications
1	12 Dec 84	13	Gray, Jim	Communications
2	3 Mar 85	1	Gray, Jim	Communications
2	11 Nov 85	4	Gray, Jim	Communications
3	1 Jan 86	7	Gray, Jim	Communications
3	2 Feb 86	8	Gray, Jim	Communications
3	3 Mar 86	10	Scidmore, Al	Communications
3	5 May 86	2	Gray, Jim	Communications
3	5 May 86	17	Beckett, Catherine	Communications
3	7 Jul 86	8	Boulouse, Elliott	Communications
3	7 Jul 86	9	Houk, David	Communications
3	7 Jul 86	12	Carr, Peter	Communications
3	7 Jul 86	18	Sasson, Jack	Communications
3	8 Aug 86	1	S.O.A.R.	Communications
1	2 Feb 84	4	Gray, Jim	Communications, Forecasts
1	5 May 84	1	Spear, Charlie	Communications, Kit Review
3	5 May 86	17	Dees, Gene	Communications, LSF
3	7 Jul 86	6	Eberbach, Dieter	Communications, Thermalling
1	11 Nov 84	6	Watt, Coulter	Construction
2	7 Jul 85	15	Parsons, Dan	Construction
2	11 Nov 85	7	Gray, Jim	Construction
2	11 Nov 85	10	Raymond, Ron	Construction
3	2 Feb 86	18	Rondeau, Bob	Construction
3	6 Jun 86	1	Riggle, Jim	Construction
3	8 Aug 86	9	Andrew, David	Construction
3	2 Feb 86	12	Jackson, Eric	Construction, 2M
3	2 Feb 86	14	Beckett, Tony	Construction, Batteries
1	2 Feb 84	3	Costlow, Red	Construction, CA
1	8 Aug 84	1	Murray, Lee	Construction, Control

File: RCSD. REFERENCES

Report: Ref/A

VOL NO	DATE	PAGE	CONTRIBUTOR	KEY WORDS
1	8 Aug 84	2	Lightfoot, John	Construction, Control
3	4 Apr 86	15	Sawyer, Ty	Construction, Control
3	3 Mar 86	19	Rondeau, Bob	Construction, Control, Sailplane
1	5 May 84	5	Watt, Coulter, et.al.	Construction, Control, Wingerons
1	11 Nov 84	3	Adams, Chris	Construction, F3B
1	12 Dec 84	11	Troy, Jeff	Construction, Fiberglass
3	6 Jun 86	23	Keyes, Charlie	Construction, Finishing
1	6 Jun 84	2	MacKay, Robert	Construction, Foam
1	12 Dec 84	11	Mid-Pacific Soaring Soc	Construction, Foam
2	1 Jan 85	6	Watt, Coulter	Construction, Fuselage
2	2 Feb 85	3	Marsden, Eric	Construction, Fuselage
2	5 May 85	16	Rondeau, Bob	Construction, Fuselage
2	8 Aug 85	3	Cash, Jack	Construction, Fuselage
2	8 Aug 85	8	Simmonds, Ken	Construction, Fuselage
1	8 Aug 84	4	Abell, Bruce	Construction, Fuselage, Fiberglass
2	3 Mar 86	1	Smiley, Clark	Construction, Fuselage, Fiberglass
2	6 Jun 85	4	Bame, Mike	Construction, Fuselage, Fiberglass
3	3 Mar 86	8	Abell, Bruce	Construction, Fuselage, Launching
3	1 Jan 86	14	Hallett, Richard	Construction, Launching
2	1 Jan 85	2	Troy, Jeff	Construction, Spoilers, Design
3	2 Feb 86	12	Currington, Ernest	Construction, Stabilizer
3	3 Mar 86	7	Rondeau, Bob	Construction, Trimming
1	2 Feb 84	5	Anderson, Roy	Construction, Wing
1	3 Feb 84	3	Baron, Charles	Construction, Wing
1	3 Mar 84	13	Thermalist, The	Construction, Wing
1	6 Jun 84	4	Gutman, Meyer	Construction, Wing
1	7 Jul 84	2	Arana, Jerry	Construction, Wing
1	7 Jul 84	6	Abell, Bruce	Construction, Wing
2	1 Jan 85	4	Tyrie, Jim	Construction, Wing
2	5 May 85	15	Sawyer, Ty	Construction, Wing
2	9 Sep 85	5	Tyrie, Jim	Construction, Wing
3	5 May 86	3	Dulno, John	Construction, Wing
3	6 Jun 86	3	Blanchard, Stewart	Construction, Wing
2	8 Aug 85	16	O'Leary, Stephen	Construction, Wing, Aerodynamics
2	7 Jul 85	1	Custer, Wayne	Construction, Wing, Finishing
2	7 Jul 85	4	DeNoble, Ray	Construction, Wing, Finishing
1	4 Apr 84	6	Abell, Bruce	Construction, Wing, Foam
1	8 Aug 84	7	Beckett, Tony	Construction, Wing, Foam
2	10 Oct 85	11	Custer, Wayne	Construction, Wing, Foam
1	8 Aug 84	5	Watt, Coulter	Construction, Wing, Foam, F3B
3	6 Jun 86	18	Sawyer, Ty, et.al.	Construction, Wing, Kit Review
1	11 Nov 84	5	DeNoble, Ray	Construction, Wing, Stabilizer
1	3 Mar 84	7	Sealy, Bob	Contests
1	10 Oct 84	2	Gray, Jim	Contests
1	11 Nov 84	4	Trim, John	Contests
1	11 Nov 84	6	Bonnell, Rich	Contests
2	1 Jan 85	3	Troy, Jeff	Contests
2	1 Jan 85	4	Webb, Kevin	Contests
2	4 Apr 85	5	Deck, Jim	Contests
2	9 Sep 85	7	Gray, Jim	Contests
3	1 Jan 86	2	Harden, Kale	Contests
3	2 Feb 86	19	Beckett, Tony	Contests
3	3 Mar 86	11	Slobod, Ed	Contests
3	4 Apr 86	5	Webb, Kevin	Contests
3	4 Apr 86	13	Abell, Bruce	Contests, 2M
2	10 Oct 85	7	Gunn, Ian	Contests, Communications
3	6 Jun 86	17	Gray, Jim	Contests, Communications
3	7 Jul 86	12	Abel, Bruce	Contests, Communications
1	10 Oct 84	3	Stokely, Herk	Contests, F3B
2	7 Jul 85	6	Harden, Kale	Contests, F3B
2	8 Aug 85	3	Bonnell, Rich	Contests, Fuselage, Construction
2	2 Feb 85	5	Webb, Neil	Contests, HLG
1	10 Oct 84	11	Johnson, Dave	Contests, Landing
1	11 Nov 84	5	Shaw, Stan	Contests, Thermalling
2	1 Jan 85	5	Fraser, David	Contests, Thermalling
1	8 Aug 84	8	Timberlake, Dan	Contests, X-Country
3	4 Apr 86	8	Lightfoot, John	Contests, X-Country
3	5 May 86	9	Lightfoot, John	Contests, X-Country
2	6 Jun 85	8	Rondeau, Bob	Control
2	8 Aug 85	6	Chernoff, Max	Control

File: RCSD.REFERENCES

Report: Ref/A

VOL	NO	DATE	PAGE	CONTRIBUTOR	KEY WORDS
2	6	Jun 85	16	Barry, Pat	Control, Construction
3	2	Feb 86	10	Lober, Carl	Control, Construction
2	12	Dec 85	18	Adams, Chris	Control, Design, Radio
2	6	Jun 85	2	Schug, Peter	Control, Software
1	12	Dec 84	9	Gray, Jim	Control, Thermalling
2	6	Jun 85	6	Watson, Stan	Design
1	1	Jan 84	2	Gray, Jim	F3B, Communications
1	3	Mar 84	7	Stokely, Herk	F3B, Contests, Communications
1	6	Jun 84	8	Witt, Elbert et al.	Fiberglass
1	6	Jun 84	8	Abell, Bruce	Fiberglass
1	9	Sep 84	5	Troy, Jeff	Finishing
1	9	Sep 84	6	Bates, Ken; et al	Finishing
1	10	Oct 84	4	Siren, Jim	Finishing
1	11	Nov 84	9	Caso, Rob	Finishing
1	9	Sep 84	3	Stokely, Herk	Flaps, Wing, Aerodynamics
2	19	Oct 85	6	McLeod, Dan	Flying
3	7	Jul 86	0	Sawyer, Ty	Flying Wings, Flaperons, Winglets
3	4	Apr 86	1	Gray, Jim	Forecasts
1	5	May 84	8	Dodgson, Bob	Kit Review
2	6	Jun 85	12	Champine, Bob	Kit Review
1	1	Jan 84	8	Swenson, Ross	Kit Review, 2M
1	12	Dec 84	8	Benson, John	Kit Review, 2M
2	8	Aug 85	11	Sawyer, Ty	Kit Review, 2M
3	8	Aug 86	14	Gracey, Bob, et.al.	Kit Review, 2M
2	12	Dec 85	3	Gracey, Bob	Kit Review, 2M, HLG
3	1	Jan 86	11	White, Clyde	Kit Review, Construction
3	2	Feb 86	15	Spear, Charlie	Kit Review, Electric, Std
1	11	Oct 84	10	Walbank, Sean	Kit Review, HLG
2	11	Nov 85	0	Sawyer, Ty	Kit Review, HLG
3	7	Jul 86	2	Finch, Harry	Kit Review, Slope Soaring
3	3	Mar 86	15	Benson, John	Kit Review, Slope Soaring, HLG
1	11	Nov 84	3	Champine, Bob	Kit Review, Std
2	7	Jul 85	2	Ferris, Jeff	Kit Review, Std
1	4	Apr 84	1	Sealy, Bob	Kit Review, Unl
3	8	Aug 86	8	Jackson, Eric	Kit Review, Unl
3	8	Aug 86	6	Gray, Jim	Kit Review, Unl, Autopilot
2	4	Apr 85	4	Moore, Bud	Launching
2	5	May 85	2	Moore, Bud	Launching
2	12	Dec 85	7	Smith, J. Lee	Launching
3	3	Mar 86	9	Smith, J. Lee	Launching
3	6	Jun 86	12	Miller, Dick	Launching
3	5	May 86	5	Murray, Lee	Launching
3	2	Feb 86	15	Currayton, Ernest	Launching, Aerodynamics
3	1	Jan 86	15	Sawyer, Ty	Launching, Fuselage, Design
1	2	Feb 84	10	Haycroft, George	Launching, Sailplane, Scale
1	1	Jan 84	9	Cheney, Bob	Launching, Turn-around
1	3	Feb 84	6	Blakeslee, Byron, et.al	Launching, Turn-around
2	4	Apr 85	14	Champine, Bob	Launching, Winch
1	3	Mar 84	14	Gray, Jim	Launching, Winch, Construction
1	10	Oct 84	6	Murray, Lee	Launching, Winch, Design
2	4	Apr 85	9	Cheney, Bob	Launching, Winch, Design
2	6	Jun 85	12	Champine, Bob	Launching, Winch, Design
2	7	Jul 85	5	Gray, Jim	LSF
1	3	Mar 84	10	LSF	LSF, Communications
1	2	Feb 84	8	Carr Peter	LSF, Slope Soaring
1	7	Jul 84	7	McQueen, Ian L.	Powered Flight, Launching
2	5	May 85	1	Savage, Gerry	Radio, Batteries
2	12	Dec 85	15	Sawyer, Ty	Radio, Batteries
2	3	Mar 85	0	Rondeau, Bob	Sailplane
2	8	Aug 85	0	Smiley, Clark & Jim Tyr	Sailplane, 2M
2	10	Oct 85	0	Rondeau, Bob	Sailplane, 2M
3	3	Mar 86	0	Gray, Jim	Sailplane, 2M
1	7	Jul 84	0	Abell, Peter	Sailplane, 2M design
1	8	Aug 84	7	O'Leary, Stephen	Sailplane, Aerodynamics
2	10	Oct 85	14	Hampson, Craig	Sailplane, Construction
2	12	Dec 85	2	Hampson, Craig	Sailplane, Construction
2	12	Dec 85	0	Rondeau, Bob	Sailplane, Control, 2M, Design
1	8	Aug 84	8	Abell, Bruce	Sailplane, Design
1	9	Sep 84	0	Gray, Jim	Sailplane, Design
1	10	Oct 84	5	Gray, Jim	Sailplane, Design
2	1	Jan 85	0	Cook, Bob	Sailplane, Design

File: RCSD.REFERENCES

Report: Ref/A

VOL	NO	DATE	PAGE	CONTRIBUTOR	KEY WORDS
3	4	Apr 86	0	Parker, Eric	Sailplane, Design
2	5	May 85	0	Martin, Bob	Sailplane, Design, 2M
2	12	Dec 85	16	Rondeau, Bob	Sailplane, Design, 2M
3	1	Jan 86	12	Rondeau, Bob	Sailplane, Design, 2M
1	1	Jan 84	0	Decker, R., et.al.	Sailplane, Design, F3B
1	6	Jun 84	0	Gray, Jim	Sailplane, Design, F3B
1	10	Oct 84	7	Edeberg, Don	Sailplane, Design, F3B
2	4	Apr 85	0	Pfefferkorn, Dieter	Sailplane, Design, F3B
2	4	Apr 85	1	Walbank, Sean	Sailplane, Design, F3B
3	1	Jan 86	0	Gray, Jim	Sailplane, Design, F3B
3	2	Feb 86	0	Bird, Phil & Lowe, Al	Sailplane, Design, F3B
3	5	May 86	0	Cotton, Fred	Sailplane, Design, F3B
1	5	May 84	0	Gray, Jim	Sailplane, Design, HLG
2	6	Jun 85	0	Cook, Bob	Sailplane, Design, HLG
3	4	Apr 86	5	Simons, Martin	Sailplane, Design, HLG
3	6	Jun 86	0	Benson, John	Sailplane, Design, HLG
2	7	Jul 85	0	Marske, Jim	Sailplane, Design, Scale
3	1	Jan 86	10	Carter, Ron	Sailplane, Design, Slope Soaring
1	3	Feb 84	0	Gray, Jim	Sailplane, Design, Std.
1	4	Apr 84	0	Gray, Jim	Sailplane, Design, Unl
1	5	May 84	4	Murray, Lee	Sailplane, Design, Unl
1	10	Oct 84	1	Clarke, John	Sailplane, Design, Unl
1	12	Dec 84	0	Champine, Bob	Sailplane, Design, Unl
2	6	Jun 85	1	Holland, Chuck	Sailplane, Design, Unlimited
2	1	Jan 85	10	Mackey, Bob	Sailplane, Design, Wingerons
1	4	Apr 84	7	Murray, Lee	Sailplane, Design, X-Country
2	10	Oct 85	12	Abell, Bruce	Sailplane, Electric, 2M
1	8	Aug 84	0	Willard, Kent	Sailplane, F3B
1	11	Nov 84	0	Gray, Jim	Sailplane, Flying Wings
2	9	Sep 85	0	Rondeau, Bob	Sailplane, HLG
2	2	Feb 85	8	Gray, Jim	Sailplane, HLG, 2M
2	5	May 85	4	Decker, Jack	Sailplane, HLG, Aerodynamics
2	2	Feb 85	4	Lupperger, John	Sailplane, HLG, Design
2	2	Feb 85	1	Gray, Jim	Sailplane, Kit Review
2	5	May 85	6	Carr, Peter	Sailplane, Kit Review, Radio
2	10	Oct 85	2	Murray, Lee	Sailplane, Kit Review, Std
1	5	May 84	1	Rosner, Kurt	Sailplane, Powered Flight, Electric
1	6	Jun 84	7	Simons, Martin	Sailplane, Scale
2	2	Feb 85	9	Moskal, Steve	Sailplane, Scale
2	2	Feb 85	12	Knight, Gerry	Sailplane, Scale
3	5	May 86	18	Metcalf, Howard	Sailplane, Scale
2	3	Mar 85	11	Benson, John	Sailplane, Slope Soaring
2	1	Jan 85	8	Gillburg, George	Sailplane, Slope Soaring, Scale
2	11	Nov 85	6	Martin, Bob	Sailplane, Std
3	6	Jun 86	22	Gray, Jim	Sailplane, UNL
1	4	Apr 84	3	Walbank, Sean	Sailplane, Wing, Design
3	6	Jun 86	2	Marsden, Eric	Scale, Finishing
2	4	Apr 85	6	Gray, Jim	Show Review
2	5	May 85	2	Riggie, Jim	Slope Soaring
2	10	Oct 85	6	Bodul, Mirko	Slope Soaring
2	6	Jun 85	14	Wright, NIC	Slope Soaring, Flying Sites
3	2	Feb 86	17	Lober, Carl	Slope Soaring, Flying Sites, Contests
2	4	Apr 85	4	Holland, Mike	Slope Soaring, LSF, Flying Sites
2	5	May 85	3	Landreth, Dean	Slope Soaring, LSF, Flying Sites
3	1	Jan 86	6	Metcalf, Howard	Slope Soaring, Scale
1	12	Dec 84	9	Gray, Jim	Software
1	12	Dec 84	10	Anderson, Chuck	Software, Airfoil
1	3	Mar 84	8	Granger, Ed	Software, Contests
1	7	Jul 84	8	Granger, Ed	Software, Contests
3	5	May 86	5	Murray, Lee	Software, Flying Wings
1	9	Sep 84	8	Sealy, Bob	Spollers
2	11	Nov 85	10	Gray, Jim	Spollers, Construction
2	3	Mar 85	9	Holley, Dwight	Spollers, Design, Control
3	4	Apr 86	16	Fraser, David	Stability, Aerodynamics, Software
3	7	Jul 86	15	Gale, Ferdinando	Stability, Airfoil, Aerodynamics
1	4	Apr 84	4	Watt, Coulter	Stabilizer, Foam, Design
3	5	May 86	18	Gray, Jim	Thermal, Communications
1	8	Aug 84	7	Beckett, Tony	Thermalling
1	9	Sep 84	7	Thornburg, Dave	Thermalling
2	1	Jan 85	9	Typod, Don	Trimming

NEW FROM VIKING MODELS USA

"E-Z MOUNT" BELL CRANKS: 60 - 90 - 120 DEGREE\$1.95/PAIR



EUROPA - EPOXY FUSELAGE & PLANS, \$45 PLUS \$5 S&H (UPS)

FACCTOR - DASSEL-LIKE F3B SAILPLANE; INCLUDES FUSELAGE, HATCH, AND PLANS. MAKES UP INTO 83" SPAN OR 2-M SPAN FOR 2 OR 3 CHANNELS. USES E-193 AIRFOIL. \$45 PLUS \$5 S&H.

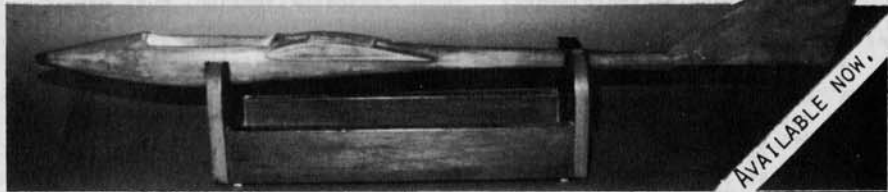

CALLISTO - EPOXY-KEVLAR FUSELAGE. NO PLANS, \$45 + \$5 S&H (UPS)



NIMBUS II - COMING SOON. 1/5TH SCALE. 154" SPAN, WORTMANN 'FOIL. FIBERGLASS FUSELAGE, CANOPY & PLANS. \$60 PLUS \$15 S&H. T-TAIL

SAILPLANE STANDS - 1" x 8" PINE, SCREWED TOGETHER. RUBBER FEET IN EACH CORNER AND A BIT OF CARPET IN THE REST AREA. CAN BE CUSTOM-CUT TO FIT YOUR OWN GLIDER, BUT USUALLY ONE SIZE FITS ALL. CAN BE USED AS SMALL FIELD BOX. HOOKS ON ENDS FOR RUBBER BAND HOLD-DOWNS WHILE TRANSPORTING.

VIKING MODELS USA

VIKING MODELS USA 2026 SPRING LAKE DRIVE, MARTINEZ, CA 94553
(415) 689-0766

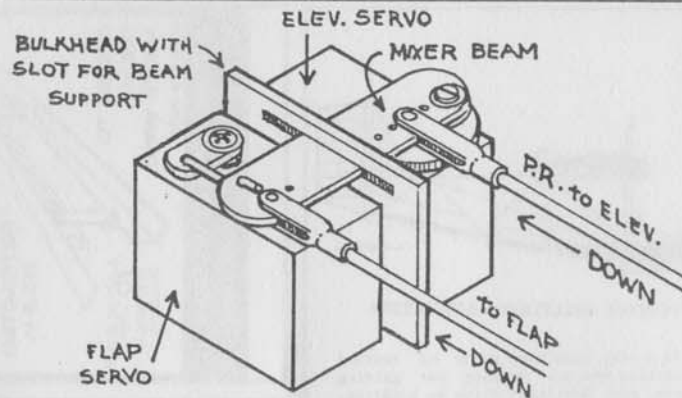

BOB RUNDEN

COMPENSATOR

FLAP/ELEVATOR-feeds in down trim when flap is deployed. Designed for side by side servo arrangement and flap/elevator have same pushrod direction. Trim ratio is adjusted by moving elev. clevis along beam. Bulkhead with slot acts to keep arm from twisting on pivot point. This is more of a problem with ball joints or E-Z connectors. Note: As trim ratio increases, total throw decreases at elevator horn.

AIRCRAFT SCALE DOCUMENTATION WORLD'S LARGEST COLLECTION

Antiques, Military, Civilian, Helicopters, Sailplanes
color FOTO-PAKS 40,000 pictures in stock
KOKU-FAN 3-views 2,000 drawings in stock
 26 page CATALOG Send \$2.00 & large S.A.S.E



SCALE MODEL RESEARCH

2334 Ticonderoga Way
Costa Mesa, CA 92626 U.S.A.
(714) 979-8058



C.D.'S, CLUBS: SEND FOR LATEST PRICE SHEET ON PLAQUES, JACKETS, T-SHIRTS, RIBBONS, NAME PLATES, AND MORE AT PRICES YOU CAN AFFORD. EVERYTHING FOR THE PRIZE WINNER. GUARANTEED QUALITY AND OLD-FASHIONED PRIDE OF WORKMANSHIP.
Fast Service Reasonable Prices in wood, metal and plastic. Stock of standard plaques and trophies always available. Ask for rates on custom designs.

(813) 327-4767

WINNING IMAGE PLAQUES

5263 - 24th Avenue N. St. Petersburg, FL 33710

